

### Specifications

		BH8525	BH13530	BH18530	BH18540	BH25030	BH25040
Press force	kN	833	1323	1813	1813	2450	2450
	ton	85	135	185	185	250	250
Bending length	mm	2600	3100	3100	4100	3100	4100
A Table length	mm	2700	3200	3200	4200	3200	4200
B Distance between frames	mm	2200	2700	2700	3700	2700	3700
C Table width	mm	170	170	170	210	210	210
D Open height	mm	380	380	380	380	380	380
E Table height	mm	900	900	900	900	900	900
F Machine depth	mm	1375	1460	1585	1610	1710	1710
G Gap depth	mm	400	400	400	400	400	400
H Height from floor	mm	2960	3000	2975	3130	3100	3230
		(2859)*	(2899)*				
I Ram stroke	mm	250	250	250	250	250	250
J Total depth	mm	2165	2315	2348	2348	2440	2440
K Safety door depth	mm	800	800	765	765	760	760
L Total width	mm	3000	3500	3730	4730	3820	4820
M Control panel turn area	mm	1230	1200	1010	1010	990	990
Ram Speed	Approach	mm/s	2~200	2~200	2~200	2~200	2~200
	Bending	mm/s	0.1~10	0.1~10	0.1~10	0.1~10	0.1~10
	Return	mm/s	2~200	2~200	2~200	2~200	2~200
Power requirement	kVA	9	12	22	22	27	27
Weight	ton	7	8.9	16	20	17.5	22

(\*: In transport condition)

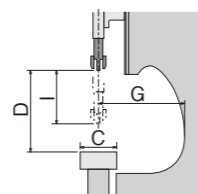
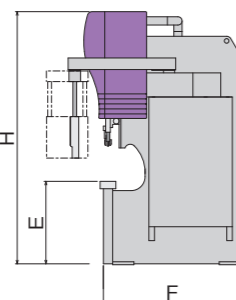
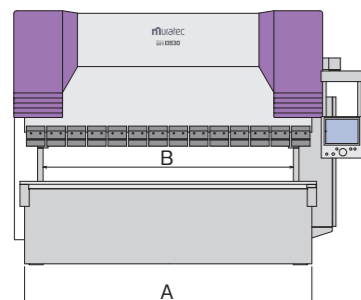
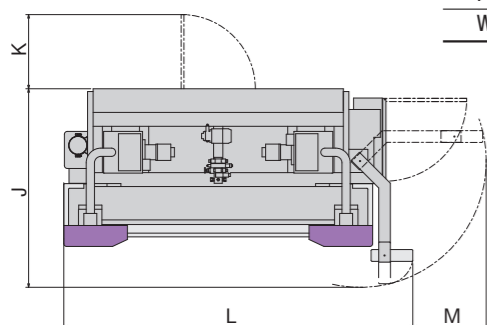

\* Machine appearance may differ to that shown in the catalogue pictures  
 \* All specifications are subject to change without advance notice

### Dual Drive Press Brake

# BH series

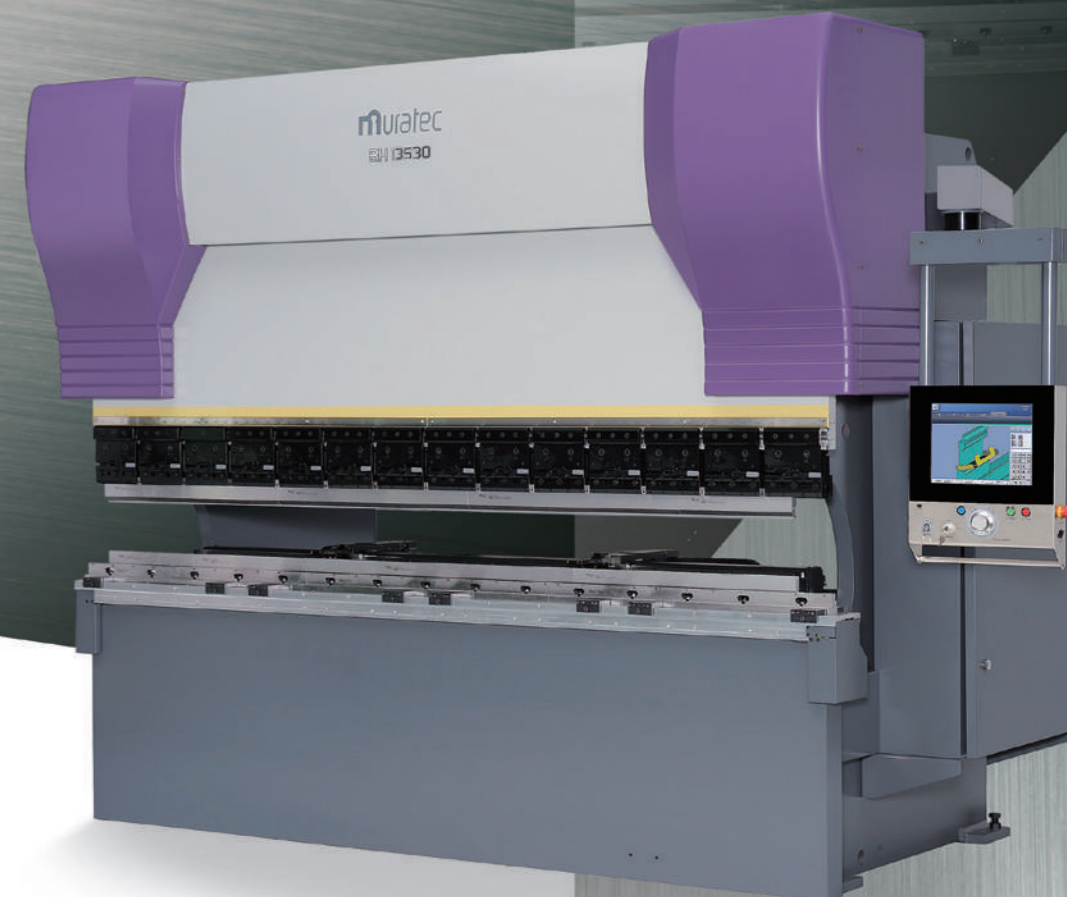

#### MURATA MACHINERY, LTD. MACHINE TOOLS DIVISION



International Business Dept.  
 2, Nakajima, Hashizume, Inuyama-shi, AICHI 484-8502, JAPAN  
 TEL: +81-(0)568-61-3645 FAX: +81-(0)568-61-6455

Headquarters  
 136, Takeda-Mukaishiro-cho, Fushimi-ku, KYOTO 612-8686, JAPAN  
 TEL: +81-(0)75-672-8138 FAX: +81-(0)75-672-8691  
 http://www.muratec.co.jp  
 e-mail info@muratec.co.jp

MURATA MACHINERY USA, INC  
 2120 Queen City Drive, P.O.Box 667609, Charlotte, N.C. 28208, U.S.A.  
 TEL: +1-704-875-9280 FAX: +1-704-392-6541  
 http://www.muratec-usa.com

MURATA DO BRASIL, LTDA.  
 Estrada de Santa Isabel, 3383-KM 38,5,  
 Itaquaquecetuba-SP, CEP 08599-000, BRASIL  
 TEL: +55 (0)11-4648-6222 FAX: +55 (0)11-4648-6737  
 http://www.muratec.com.br  
 e-mail muratec@muratec.com.br

MURATA MACHINERY EUROPE GmbH  
 Hanns-Martin-Schleyer-Straße 3, D-47877, Willich, GERMANY  
 TEL: +49-(0)2154-914-250 FAX: +49-(0)2154-914-283  
 http://www.muratec-europe.de/  
 e-mail info@muratec.de

MURATA MACHINERY (SHANGHAI) CO.,LTD  
 [Registry Add]  
 135 Fu Te Xi Yi Rd., Wai Gao Qiao Free Trade Zone,  
 Pudong, Shanghai, CHINA  
 [Contact Add]  
 150 Xin Gao Rd., Qingpu Industrial Zone,  
 Shanghai, 201700, CHINA  
 TEL: +86-(0)21-6921-2300 FAX: +86-(0)21-6921-2330  
**BEIJING BRANCH**  
 Rm. 309 Yu Lin Bldg., Xiang Jun Nan Li Er Xiang Jia No.5,  
 Chaoyang-qu, Beijing, 100020, CHINA  
 TEL: +86-(0)10-6597-3048 FAX: +86-(0)10-6591-1795  
**GUANGZHOU BRANCH**  
 Room 635, United Star Hotel, 172 Chang Gang Rd., C.,  
 Guangzhou, 510250, CHINA  
 TEL: +86-(0)20-8434-2882 FAX: +86-(0)20-8434-3463

MURATA (THAILAND) CO., LTD.  
 898/43-44 SV CITY TOWER 2,25th Floor, Rama 3 Road  
 Bangpoo, Yannawa, Bangkok 10120, THAILAND  
 TEL: +66-(0)2294-7734-40 FAX: +66-(0)2294-7732

PT.MURATA MACHINERY INDONESIA  
 Ruko Gyan Plaza D-4, Jl.Terusan Pasirkoja Blok 8,Bandung  
 40222, INDONESIA  
 TEL: +62-(0)22-6046633 FAX: +62-(0)22-6046612

MEIBAN ENGINEERING TECHNOLOGIES PVT.LTD.  
 [An associate company of Murata Machinery, Ltd.]  
 No 38, 7th Main, J.C. Industrial Estate, Yelachanahalli, Kanakapura Road,  
 Bangalore -560 062 INDIA  
 TEL: +91-(0)80-2686-0600 Fax: +91-(0)80-2686-0605  
 http://www.meibanengg.com  
 e-mail: office@meibanengg.com

Newly developed and mounted Dual Drive System realizes improvements in productivity, high stop-accuracy, and energy savings.

Dual Drive Press Brake  
**BH series**

Muratec's Dual Drive Press Brake BH Series is mounted with a Dual Drive System which separately controls high-speed up and down movement of the ram by AC servo motor, ball screw drive and hydraulic piston down movement. The system enables high-speed drive and stable repeat-stop accuracy to realize high productivity.



BH8525



BH13530



BH18530



BH18540



BH25030



BH25040

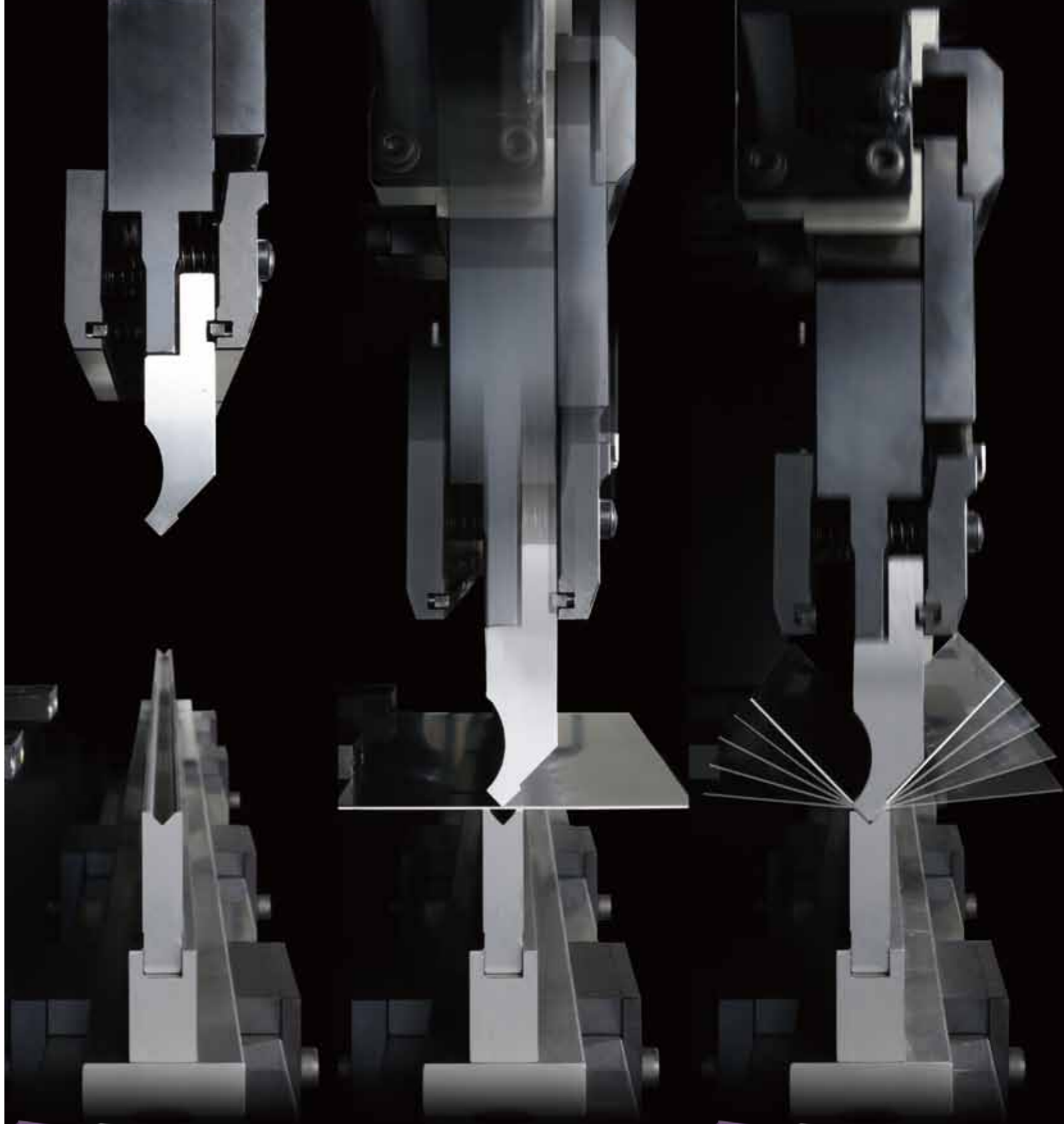



## Dual Drive System

Different from conventional servo hydraulic mechanisms which continuously control high-speed movement and pressure movement of the ram, the Dual Drive System separately controls high-speed up and down movement by AC servo motor and ball screw drive and hydraulic pressure movement. By the Dual Drive System, high-speed down-movement at 200mm/sec and stable repeat-stop accuracy by AC servo motor and hydraulic drive are enabled, realizing high productivity. In addition, the Dual Drive System is superior in total energy saving because it is fitted with a assist device that stores the energy of down movement and returns it during ram up movement.

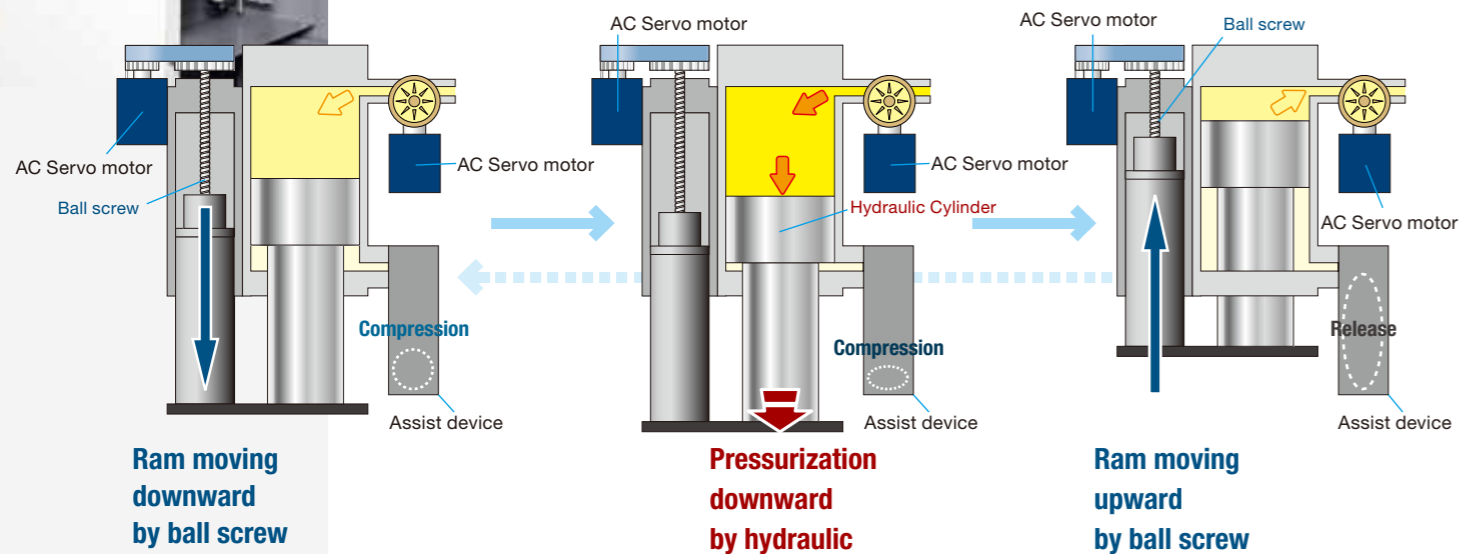

### High stop-accuracy by linear scale

In Dual Drive control, although the drive is changed to hybrid control from ball screw control in mid stroke, the position is monitored by the linear scale for full stroke. As a result, stable stop-accuracy can be secured without being affected by oil temperature or pressure.



Linear scale

### Assistance by accumulator

Assistance by the accumulator cancels the weight of the ram, enables high speed rise of the ram with a small-sized motor and ball screws and allows for silent movement and energy saving effects.

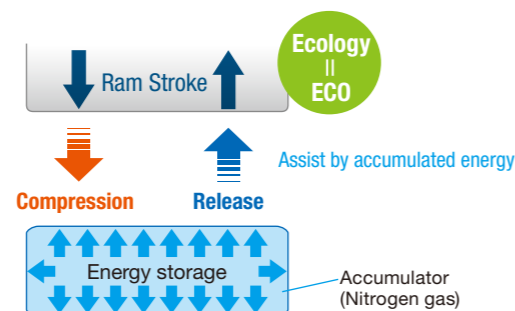

### Compact hydraulic tank



## Rigid frame/ Crowning System

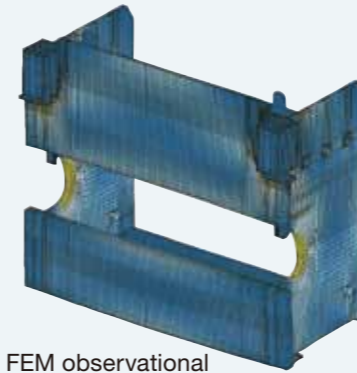

FEM observational

### Crowning adjustment

Crowning adjustment adjusts the strain of machines. Although it is ideal to minimize the strain of frames as much as possible, it is difficult in practice. Assembly of an adjusting device in a rigid frame that is suppressed in strain realizes high passing precision.

The Ideal Curve Crowning System is created by conducting FEM analysis of the frame in pursuit of the ideal correction curve with respect to crowning which becomes a problem for the press brakes. Simple and fine adjustment is enabled with use of a monoaxial curving wedge. Automatic crowning adjustment is made quickly for each bending step without stress.

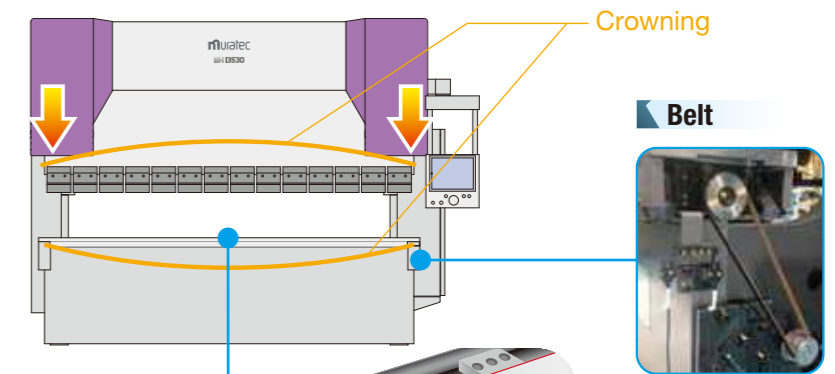

### Curving wedge inside

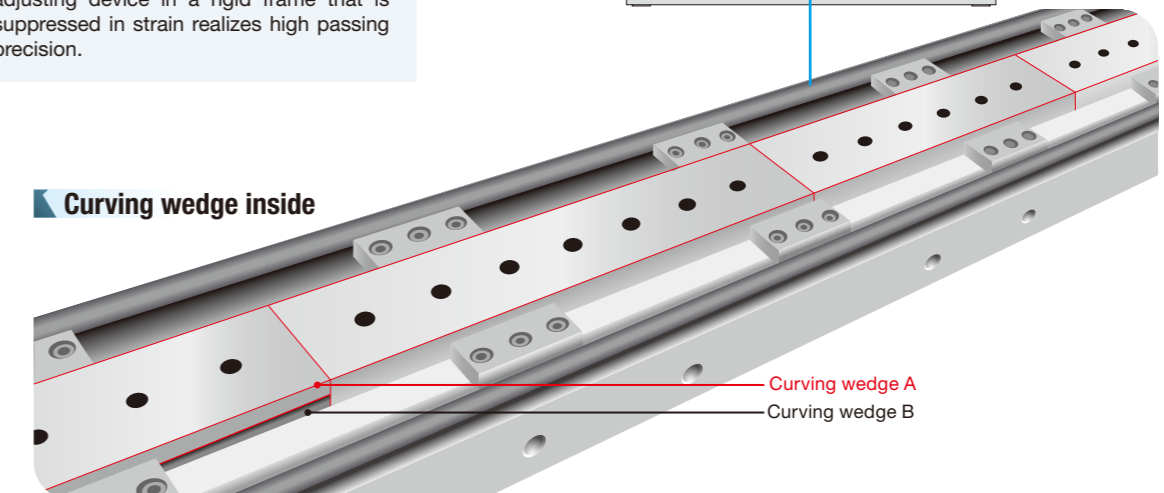

### Not adjusted

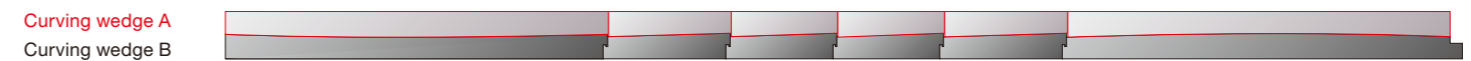

### Adjusted



Only curving wedge B is moved

Adjusted by the adjusting function in each process in a short period of time

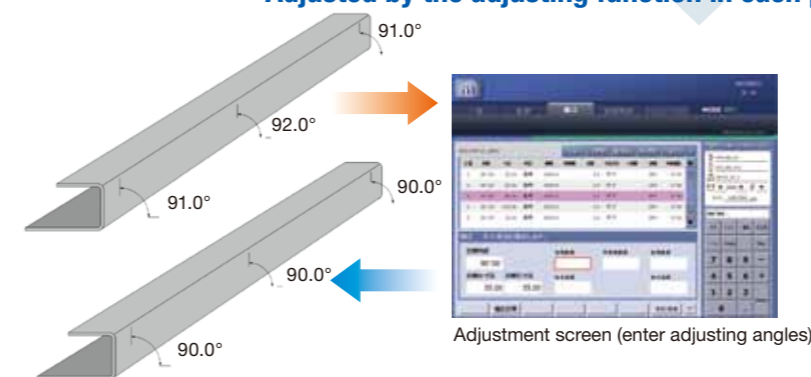

Adjustment screen (enter adjusting angles)

### Profile-based Ideal crowning correction curve

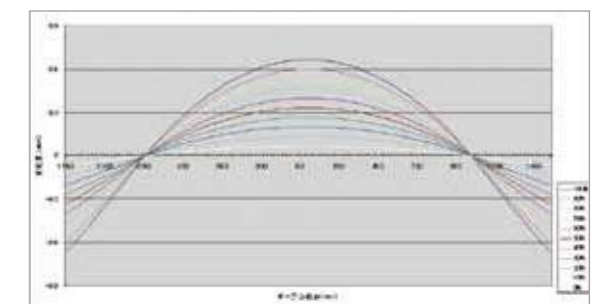

Crowning in various conditions is adjusted.



## ▶ Back gauge

### 5(7) Back gauge for axis control with high accuracy and rigidity

( ): Option

Specifications	
Y axis St 700 mm	Y axis speed 50 m/min
Z axis St 200 mm	X axis speed 50 m/min
	ZX axis speed 10 m/min

#### Back gauge handles a variety of bendings



The high-speed and high accuracy back gauge with an effective stroke of 700mm (standard specification) responds to a variety of bendings. Number of fingers: 2 (Option 4)

#### Deep and wide space



The back gauge main body is placed on the side frame to secure a deep and wide space. This enables handling a wide variety of workpieces.

## Back Gauge Finger

### Standard Finger

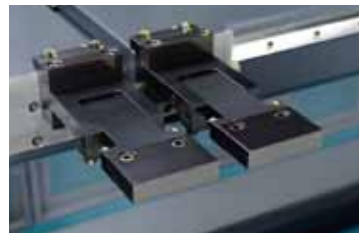

### Crab Claw Finger (Option)



### Touch Sensor (Option)

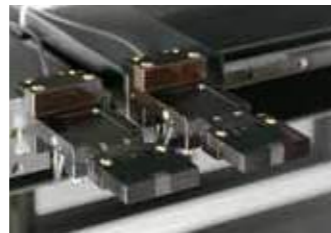

### Step Finger (Option)

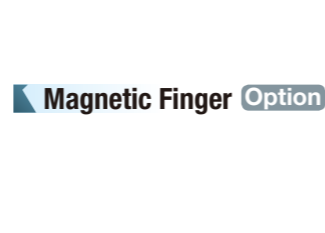

### Magnetic Finger (Option)

## ▶ Tool clamp

### Manual type

Holder for manually clamping European-style tooling



### One touch type (Option)

The one touch clamp can be opened and closed with the clamp lever and tools can be easily attached and detached.

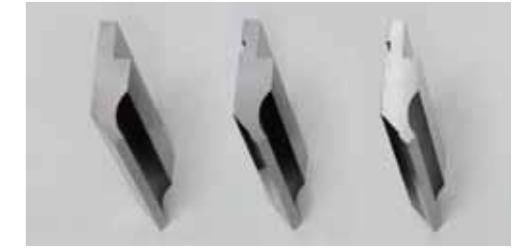

The one touch clamp can clamp any type of European tooling.

### WILA type (Option)

Compatible with the worldwide tool manufacturer WILA. Significant reduction in tool replacement time is enabled with the hydraulic clamp and safety click.



### Universal type (Option)

Compatible with both the American type and European type.

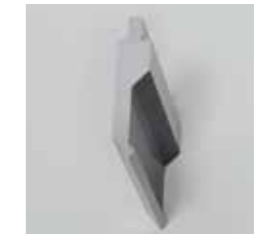

American type



European type

\* Also available as an option are tool holders for clamping various dies.

## Handling a wide variety of work pieces

### Back gauge Fingers



Materials can be placed on the upper surface of the Finger support part, therefore, stable processing is enabled without material crowning in the case where a deep material is bent.

### Tapered bending (Conical bending)



The back gauge can be tilted obliquely, it is thereby possible to easily perform obliquely abutting, etc. Depending on the shape, conical bending processing, etc., is enabled.

### Deep bending process (Box bending processing)

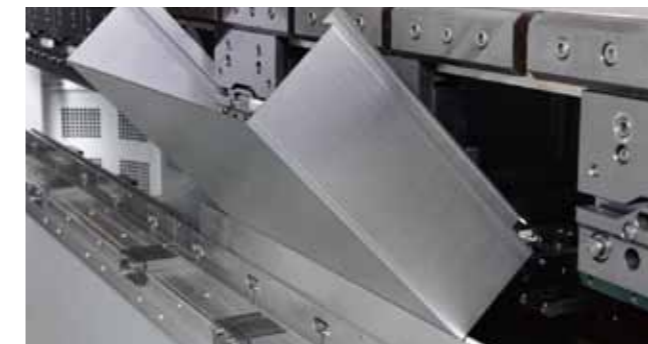

The height of the intermediate plate of the tool clamp is 150mm to allow for freely moving in the right and left directions, therefore, deep bending (box bending) processing which is common for distribution boards is enabled.

### Hollow bending processing



The intermediate plate of the tool clamp can be freely removed, therefore, bending processing which interferes with the deep U-shaped ram is enabled depending on the size.



## ▶ Control system (MNC5000)

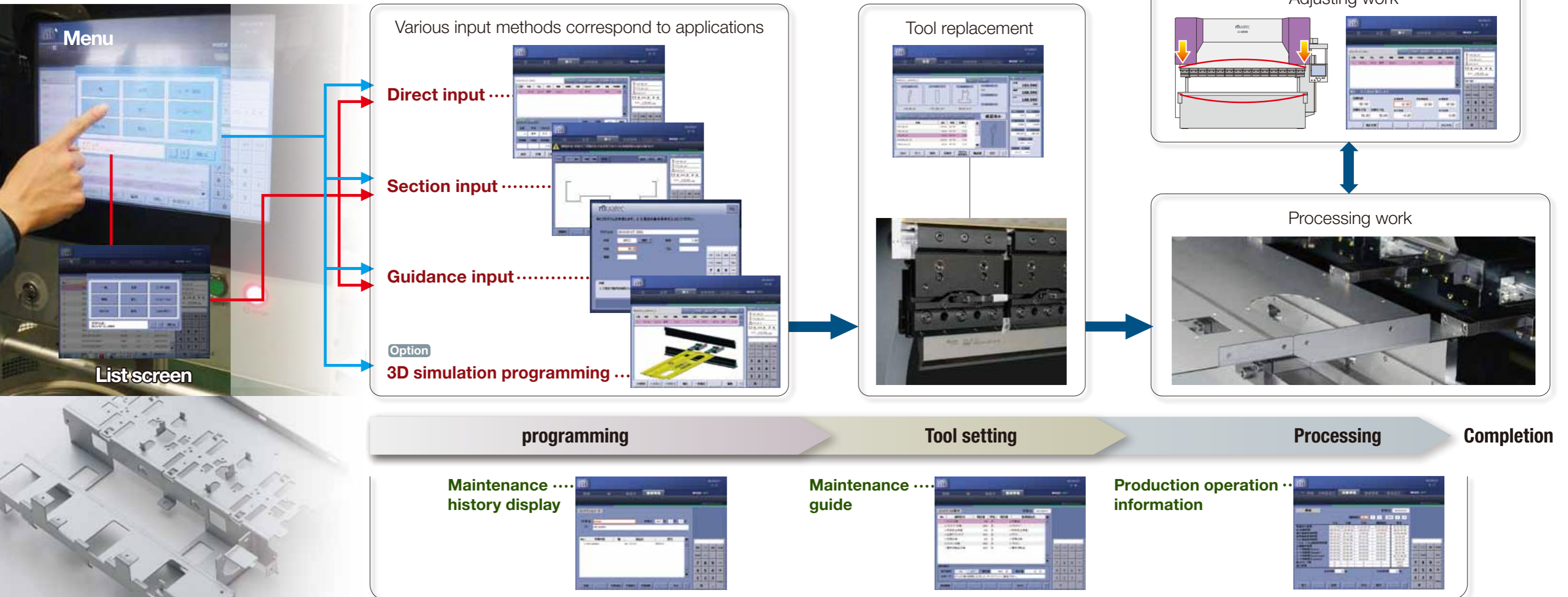

The control system with a panel computer mounting 2.2GHz Dual-Core processor and 15in TFT touch panel is a user-friendly control system superior in operability.

Panel PC  
 CPU 2.2 GHz Intel Celeron 1020E dual core processor  
 Memory 2GB  
 OS windows XP Embedded

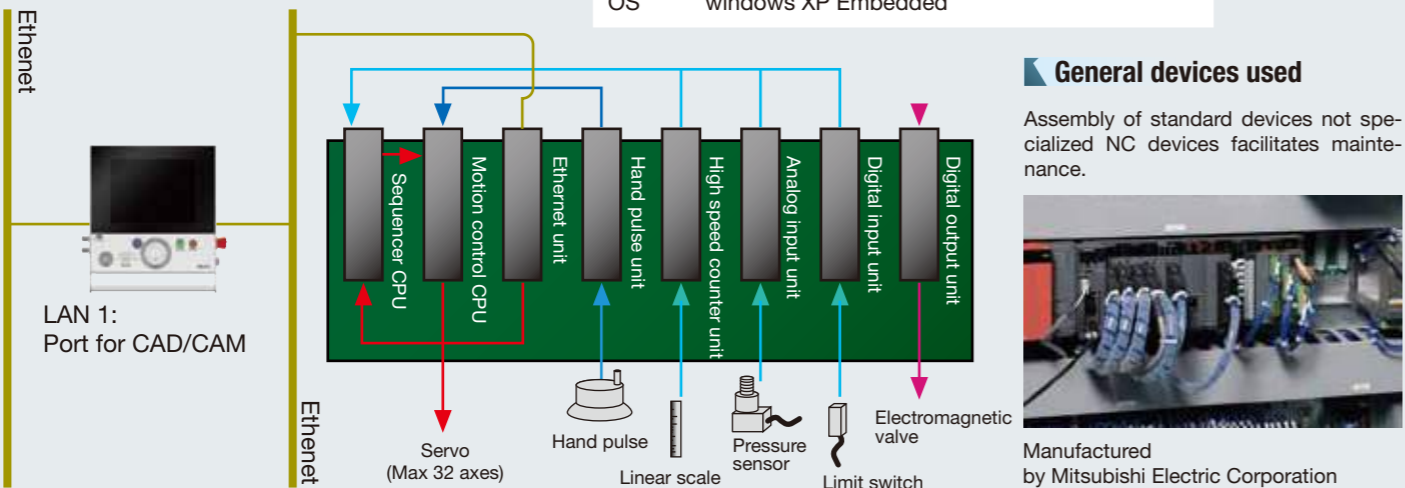

## ▶ PSP (Press Start Point) function

### PSP function

PSP function checks errors in thickness of each workpiece to suppress the variation range of angles.  
 \*Tensile strength and rolling line cannot be checked.

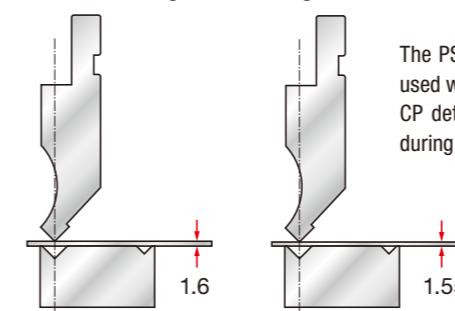

### CP detection (adjusts errors in bending angle calculations)

In CP detection, the reference point is actually measured with a bending tool and material, therefore, errors in tool height and errors in thickness of the material are adjusted to improve accuracy of bending angle calculations. (\*Workpieces targeted for automatic CP detection have conditions.)

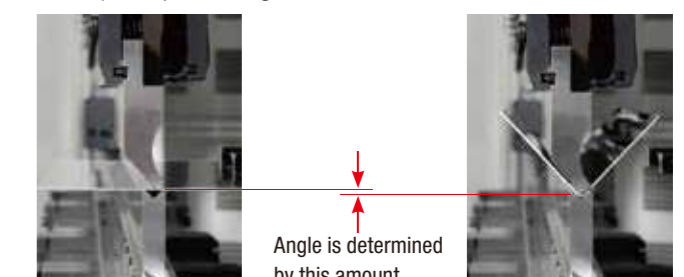



## ▶ Programming

### Direct input

Only input the required conditions makes creating programs easy.

[Input item]

条件	材質	SPCC	選択
	板厚	1.60	
	角度	90°00'	
	寸法	50.00	
	板幅	1500.0	mm表示

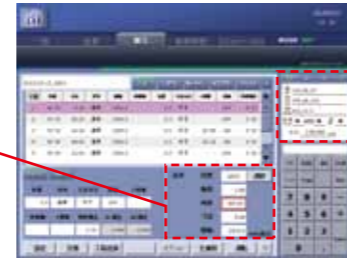

#### Workpiece information check

If there is input data, model images and unfolded view images can be displayed.



### Section input

Enables easy programming by drawing section shapes. In addition, tool interference is checked and a bending method suitable for an operator can be selected from bending search results.

[Creation of new sections]



[Select tool]



A bending order for the currently attached tool is searched and when the tool has interference, search a bending order for another tool.

[Bending order automatic search]



Search up to 1000 bending orders.

[Bending order search result display]



[Simulation check on the section display]



[Section library]



Frequently used section shapes can be registered in the library.

### Guidance input

Program creation navigation mode enables easy programming even by those who are not accustomed to direct input.

[Basic conditions]



[Additional conditions]



[Tool conditions]



[Action conditions]



[Calculation]



### Option 3D simulation programming

Theoretical data can be developed with the bending simulation data.

[Data calling]



[Data calculation]



[Simulation screen]

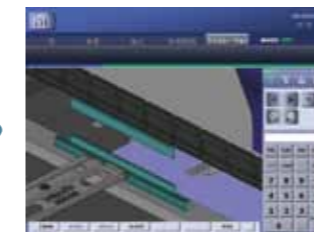

[Processing screen]





## ► Maintenance

### Maintenance history and maintenance guide

MNC5000 allows maintenance history and maintenance guide to be displayed and used as a chart of the machine. In addition, if the period of use of consumables including batteries is set, notice is displayed on the screen.

[Maintenance history display]



[Maintenance guide]



### Operation information

Performance information including machine operation information, tool usage information, and processing information can be output and effectively used for work analysis.

[Machine operation information]



Output data is processed by CSV.

Example: Work efficiency analysis

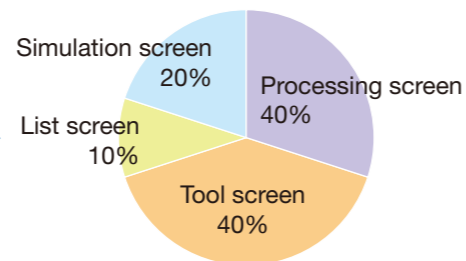

[Processing information]



Processing history is recorded and when and which program is processed can be checked.

[Tool usage information]



The number of times of use of each tool is recorded and how much and which tool is used can be checked.

## ► Network

As a general manufacturer of sheet-metal machinery, Muratec always listens to the voices of its customers from job shops to manufacturers including single machine users, automated transportation system users and large-scale FMS users irrespective of scale and type of business, builds optimal solutions for its customers, and delivers them.

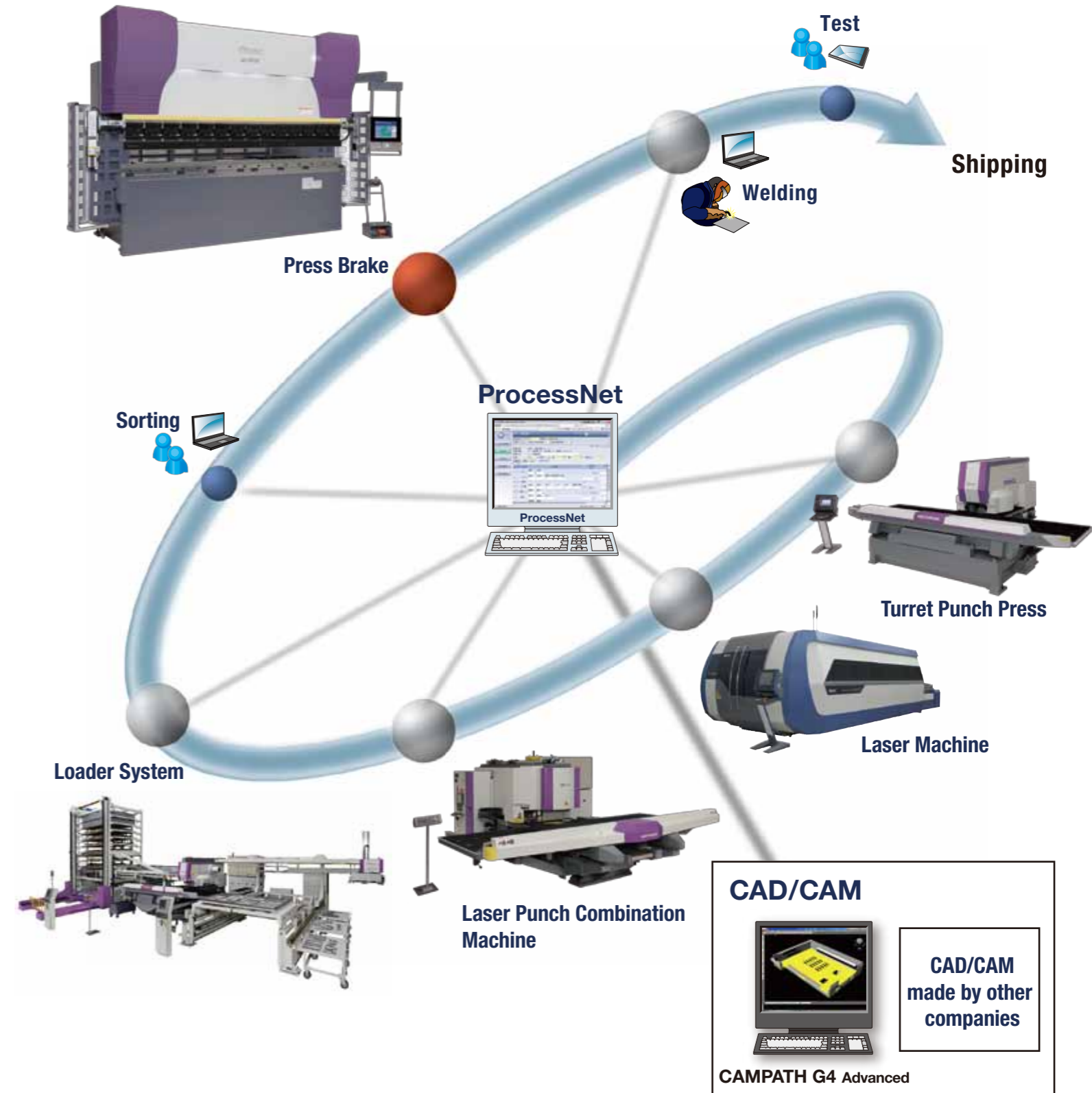



## ▶ Safety system

### LED Option



High energy-saving LED is adopted. Illuminates your hands and inside of the machine to comfortably support operators.

LED lighting for large-sized machines

### Safety pin



Insertion of a safety pin makes maintenance work safer.



### Interlocked side guard Option

Movable parts from the side of the machine are guarded to prevent unexpected hazards and ensure safe work. When the side guard is opened, the machine is inoperable until the interlock is released.

### Safety laser light system Option



DSP-J

This is a safety device for practicable press brake which allows the machine to operate as long as the speed is 10mm/sec even when a laser beam is shielded to ensure safety of operators.

AKASIII

### Special mode for tool replacement

This is a special mode for tool replacement, the speed and pressure of which are controlled in order to avoid hazards during tool replacement.



### All devices are compatible with 'Safety category level 4'



Safety related portions including the control system and the protection equipment are designed, configured, selected, and assembled in accordance with appropriate standards so as to withstand expected external influences.

\*The safety category 4 is the highest rank of safety categories specified by the safety control system of international safety standards.

\*Conforms to JIS B 6410 Servo Press safety requirements.

\*Satisfies power press mechanical structure standards revised in 2011.

## ▶ Option

### Movable foot switch



The movable foot switch demonstrates its advantages for step-bending of small articles, and supports operators in a user-friendly manner with excellent operability.

### Front support Fixed type Movable type

### Short intermediate plate

### Hydraulic follow-up device



Useful for bending large-sized and heavy workpieces and considerably reduces burden on operators. The weight capacity is 150 kg. Two suction types, a magnet type and a vacuum type, are available.

### Open height 100mm UP

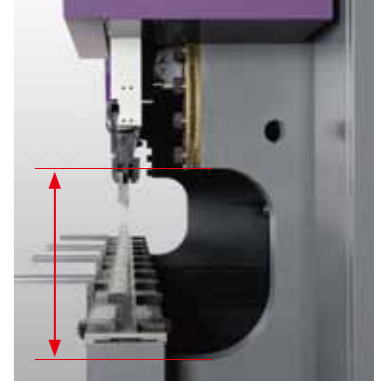

The open height (100 mm wider than standard) specification is set optionally. This improves work handling performance for the deep bending process which is frequently used for processing control panels.

## ▶ Sample

